

**NB:- EXTERNAL WALLS 90mm
INTERNAL WALLS 70mm**

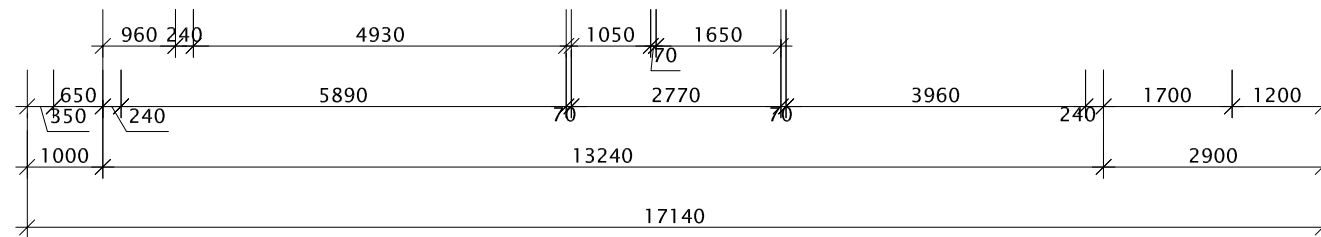

CUSTOM 204.5

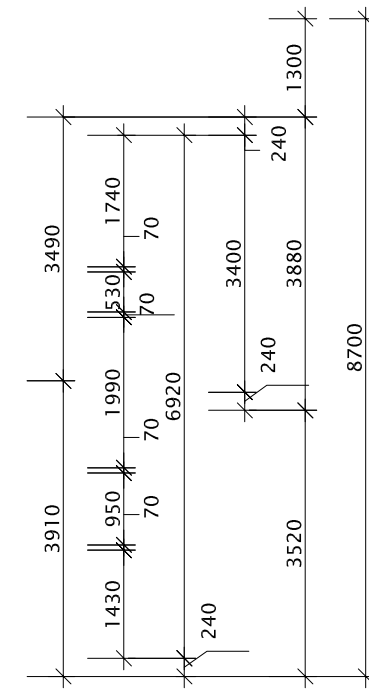
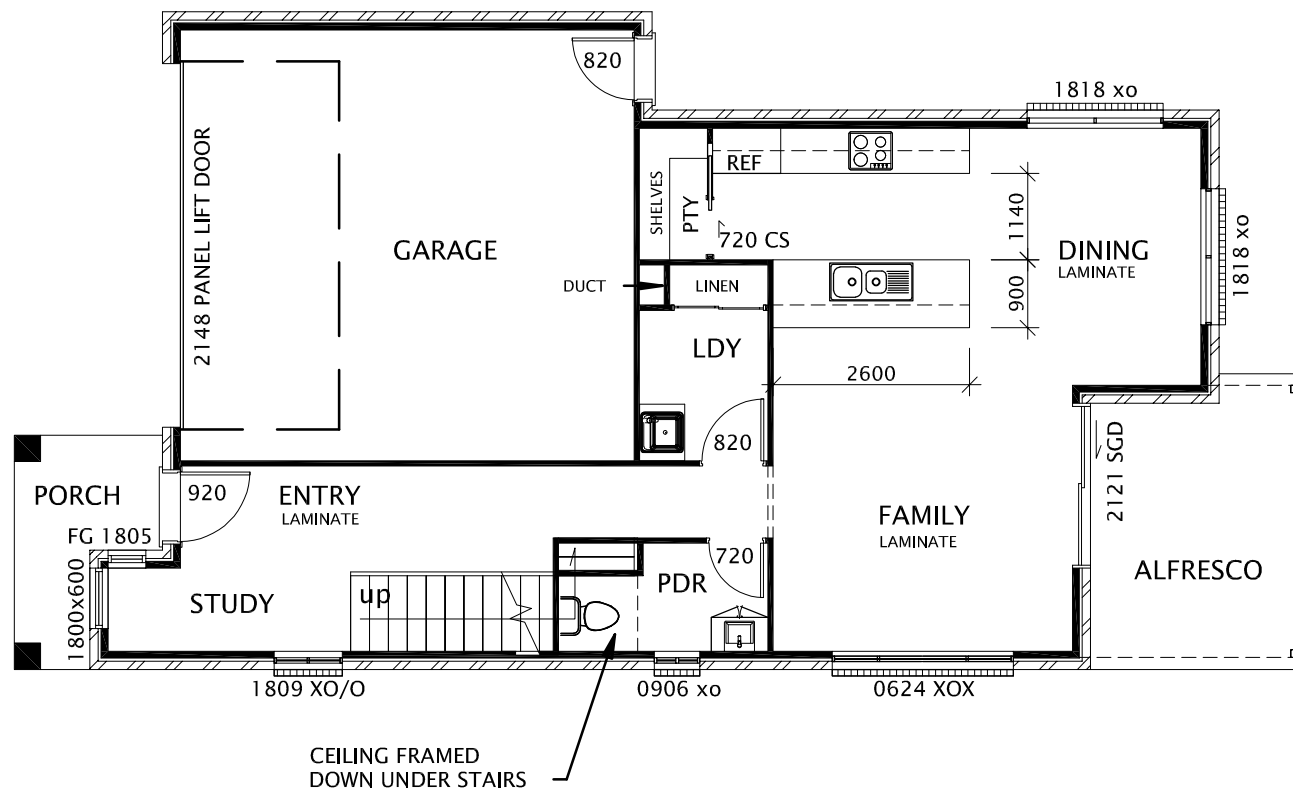
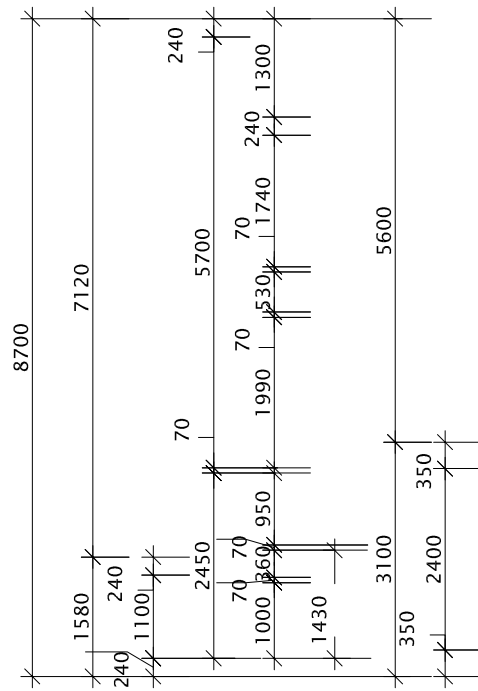
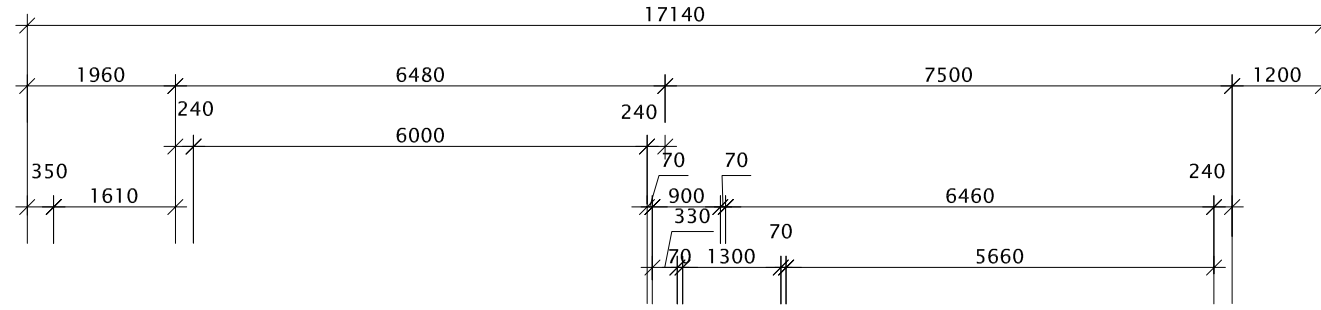
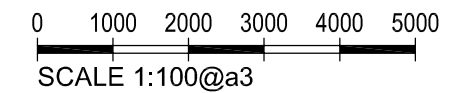

AREAS	
LOWER LIVING	70.05
UPPER LIVING	79.05
BALCONY	2.80
GARAGE	37.37
PORCH	4.55
ALFRESCO	10.67
TOTAL AREA	204.49 sq'm
FOOTPRINT	122.64 sq'm

LAMINATE 46 sqm

18/12

**PROPOSED RESIDENCE AT
LOT --**

LETSWORK™

NB:- EXTERNAL WALLS 90mm
INTERNAL WALLS 70mm

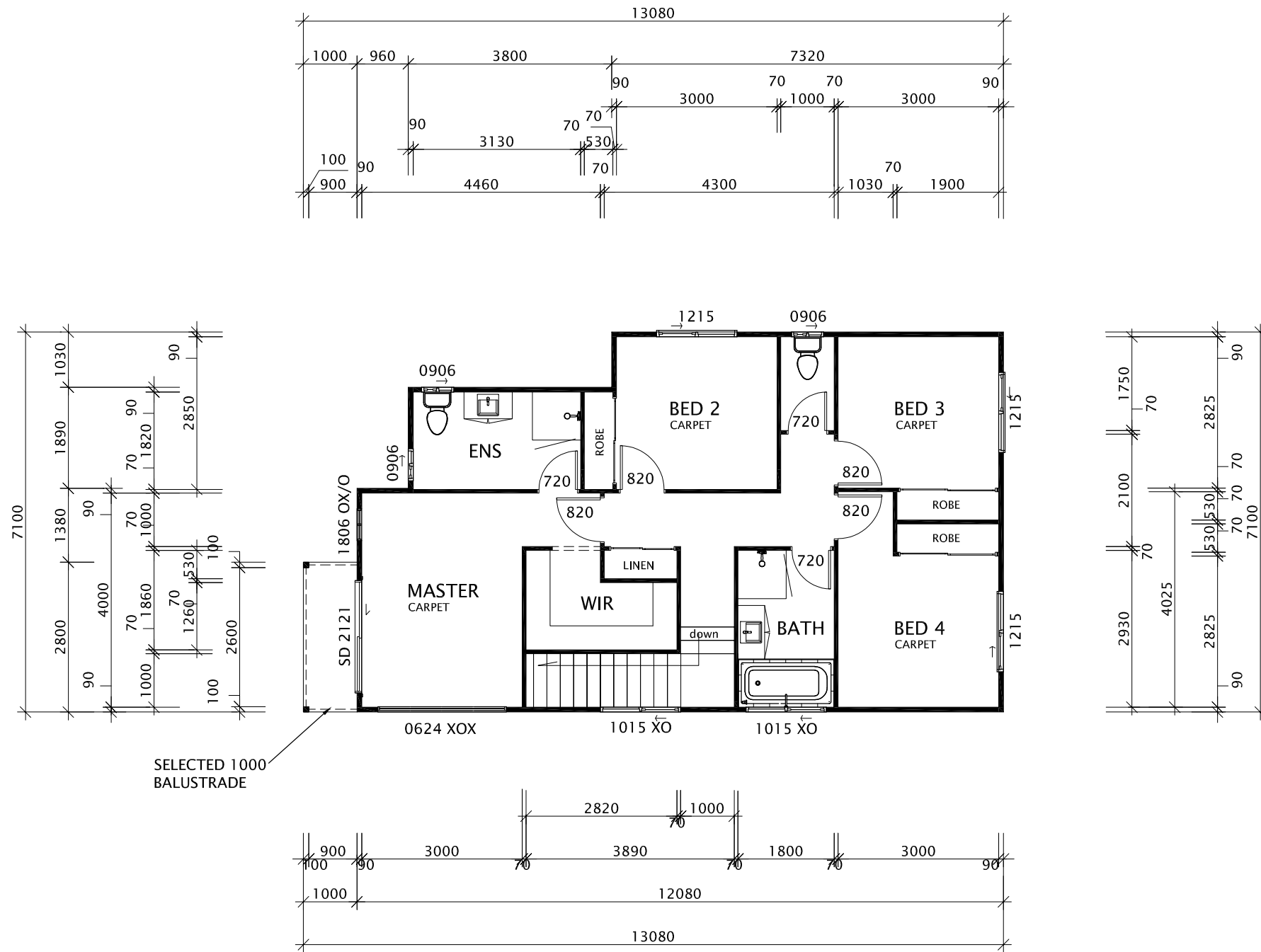

CARPET 49 sqm
LAMINATE 8 sqm

CUSTOM 204.5

18/12

PROPOSED RESIDENCE AT
LOT --

LETSWORK™